

Varenummer: 0106055
 Beskrivelse: Seeger låsering JV 38

Mål

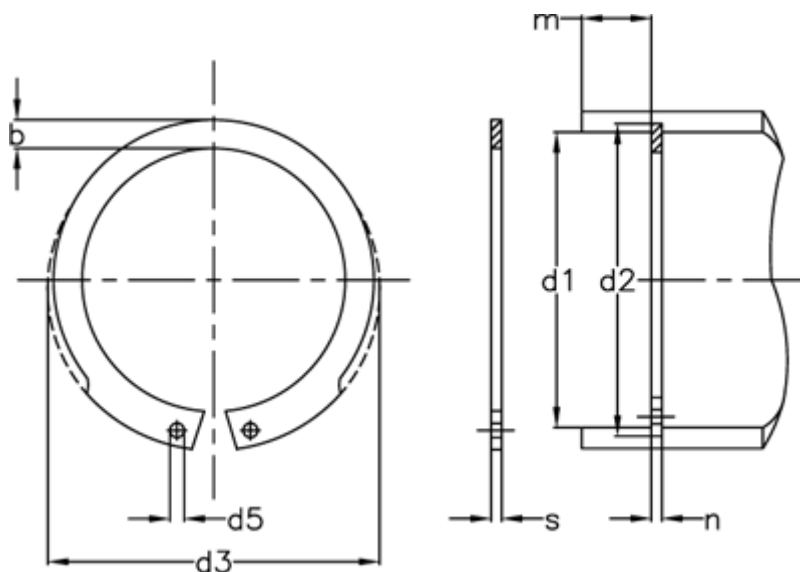

AN mm ²	= 61	FRg kN	= 6.7	Tang	= ZGJ-1
b	= 3.8	FR kN	= 28.0	tol	= -0.06
Betegnelse	= JV 38	g	= 1.5	tol	= +0,50-0,25
d1	= 38	K kN-mm	= 51.2	tol	= +0,25
d2	= 40.0	m min	= 1.60	tol	= 0.1
d3	= 40.8	Nominel træk	= 3.8	vægt kg/1000	= 3.68
d5 min	= 1.7	s	= 1.50		
FN kN	= 10.20	t	= 1.00		